

# Ahoj já jsem Barnabáš.

Vymaluj si Barnabáše a pomoz mu splnit všechny pracovní listy.

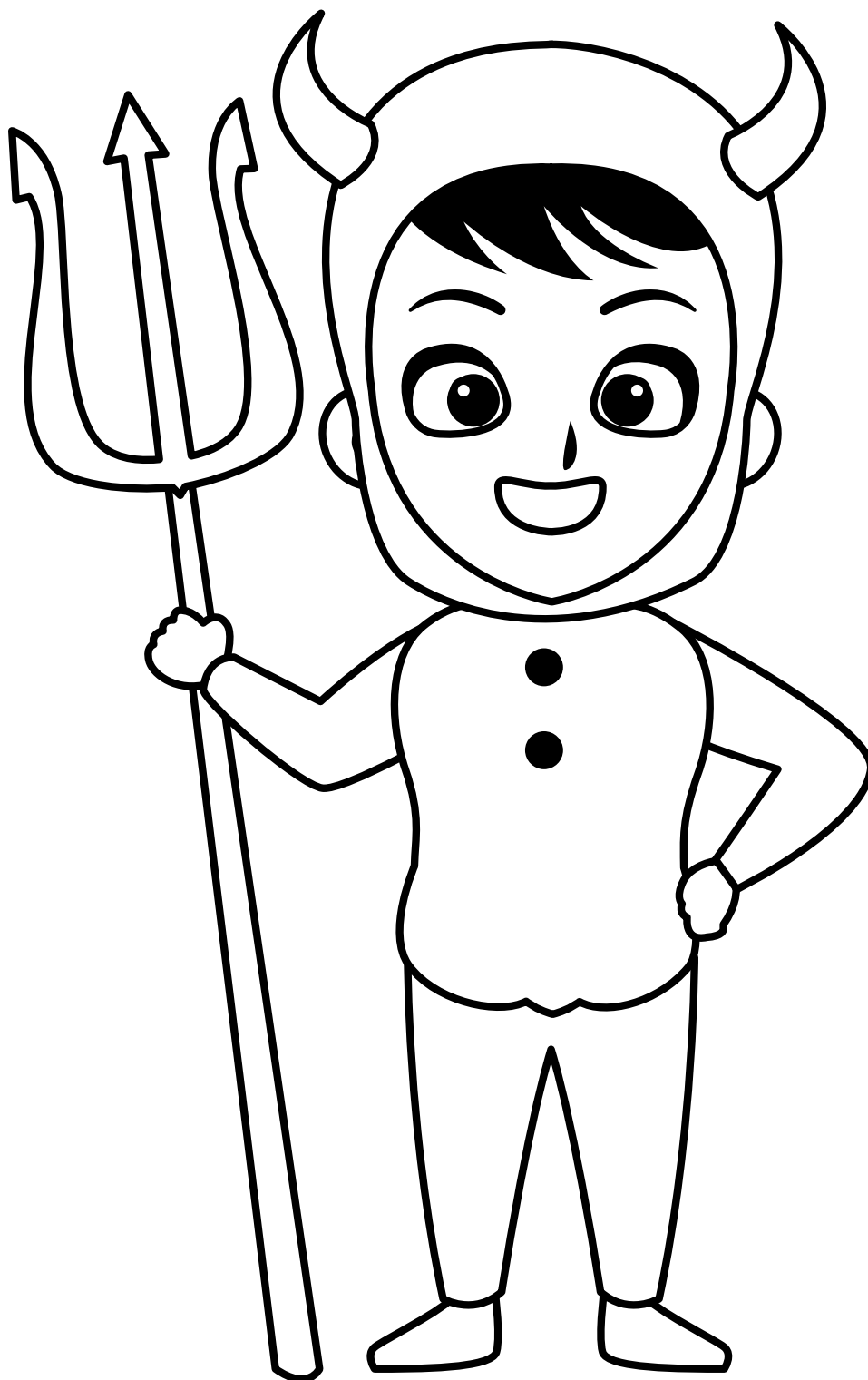

Jméno:

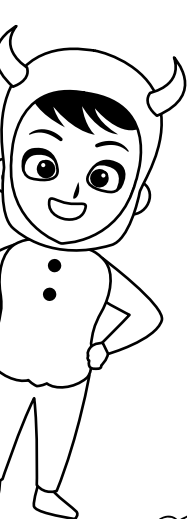

# Pomoz Barnabášovi s počítáním.

Barnabáš je ještě malý a neumí počítat. Pomůžeš mu prosím?

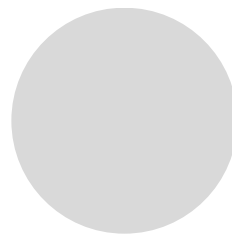
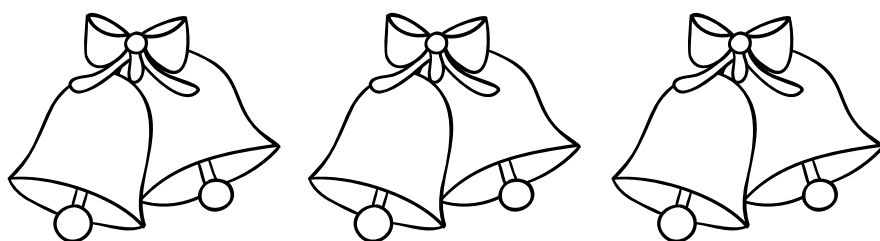
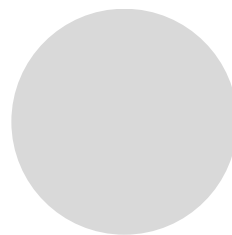
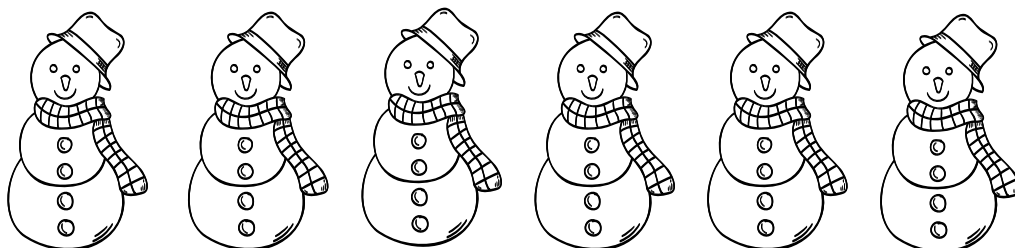
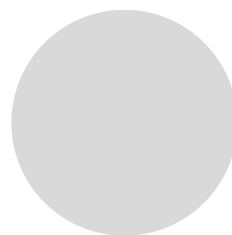
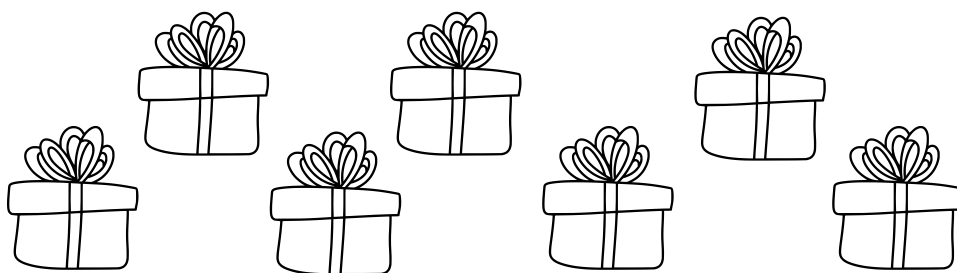
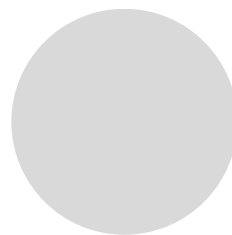
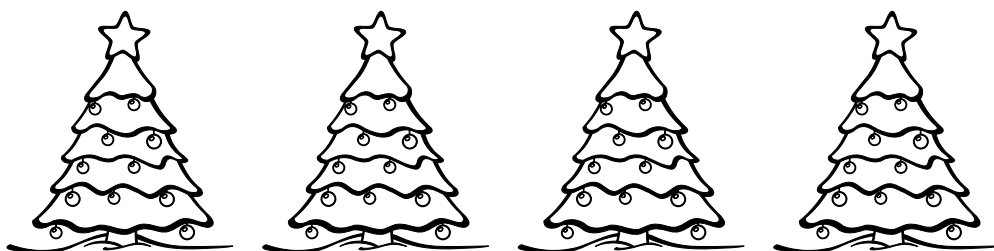
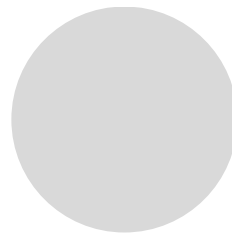
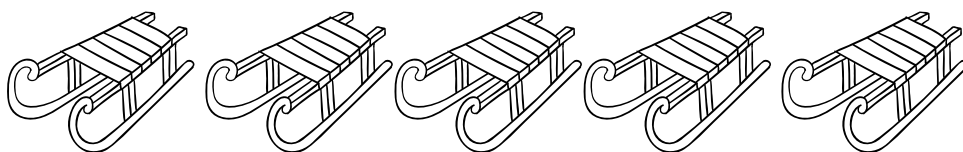

Jméno:

# V jako Vánoce.

Vymaluj vše co začíná na písmeno V.

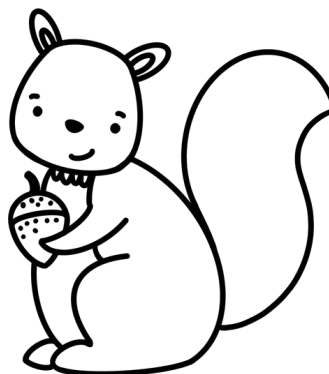
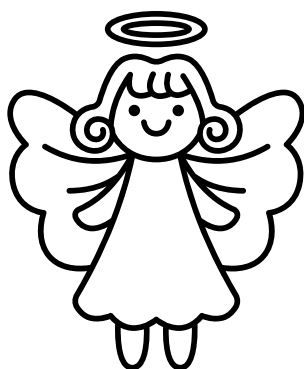
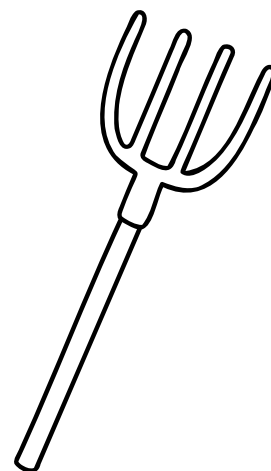
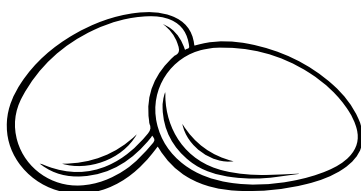
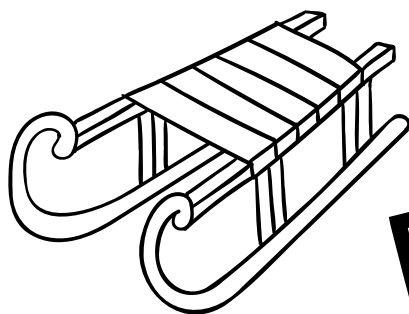
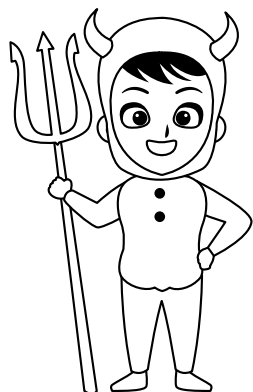

Jméno:

# Sněhulák.

Vystříhni sněhuláka a nalep ho na papír.



# Ztracené dárky.

Pomoz dostat dárek pod stromeček.

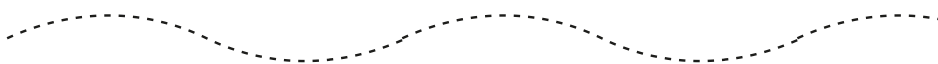

Jméno:

# Co kam patří?

Spoj obrázky které patří k sobě.

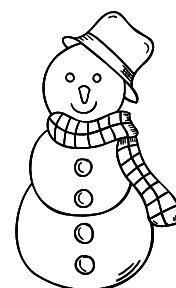
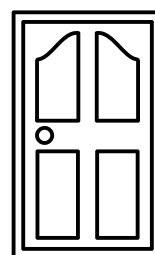
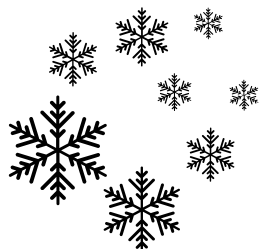

Jméno:

# Zimní počítání.

Zakroužkuj správný počet.



4 - 5 - 1

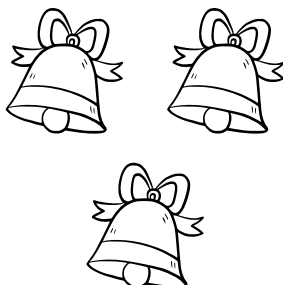

2 - 3 - 4

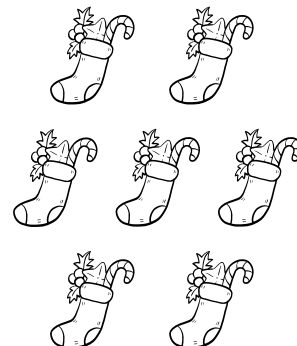

7 - 6 - 4

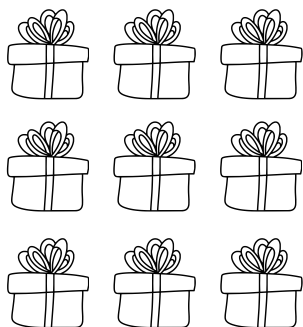

8 - 9 - 7

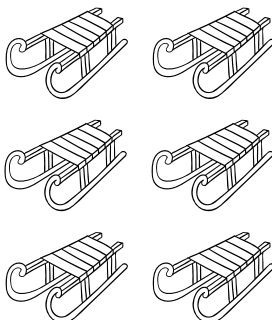

4 - 3 - 6



2 - 3 - 4

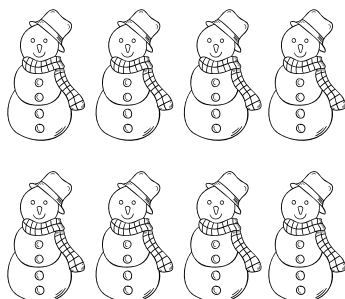

8 - 5 - 6



4 - 3 - 2



2 - 5 - 4

Jméno:

# Vytleskáme.

Kolikrát tleskneš, tolik puntíků nakresli.

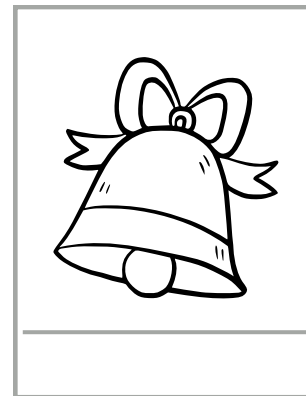
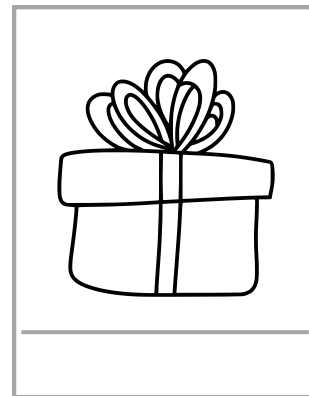
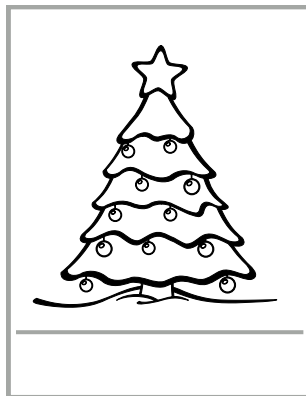
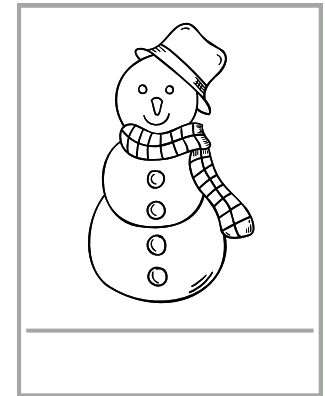
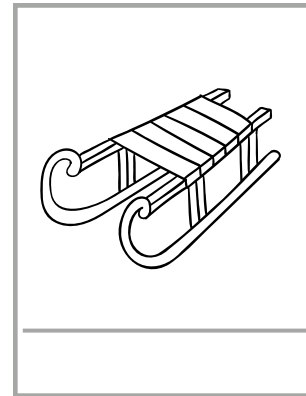
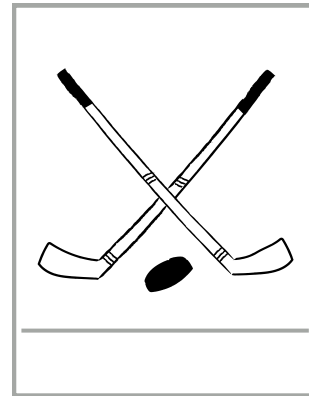
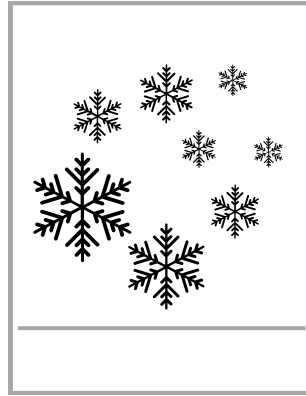
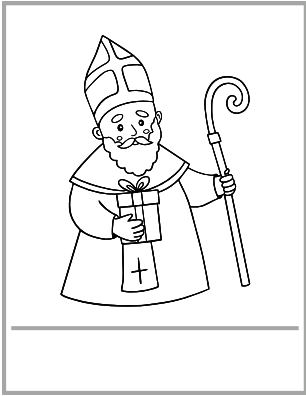

Jméno:



# Najdeš je všechny?

Vybarvi všechna písmena ve slově SNĚHULÁK.

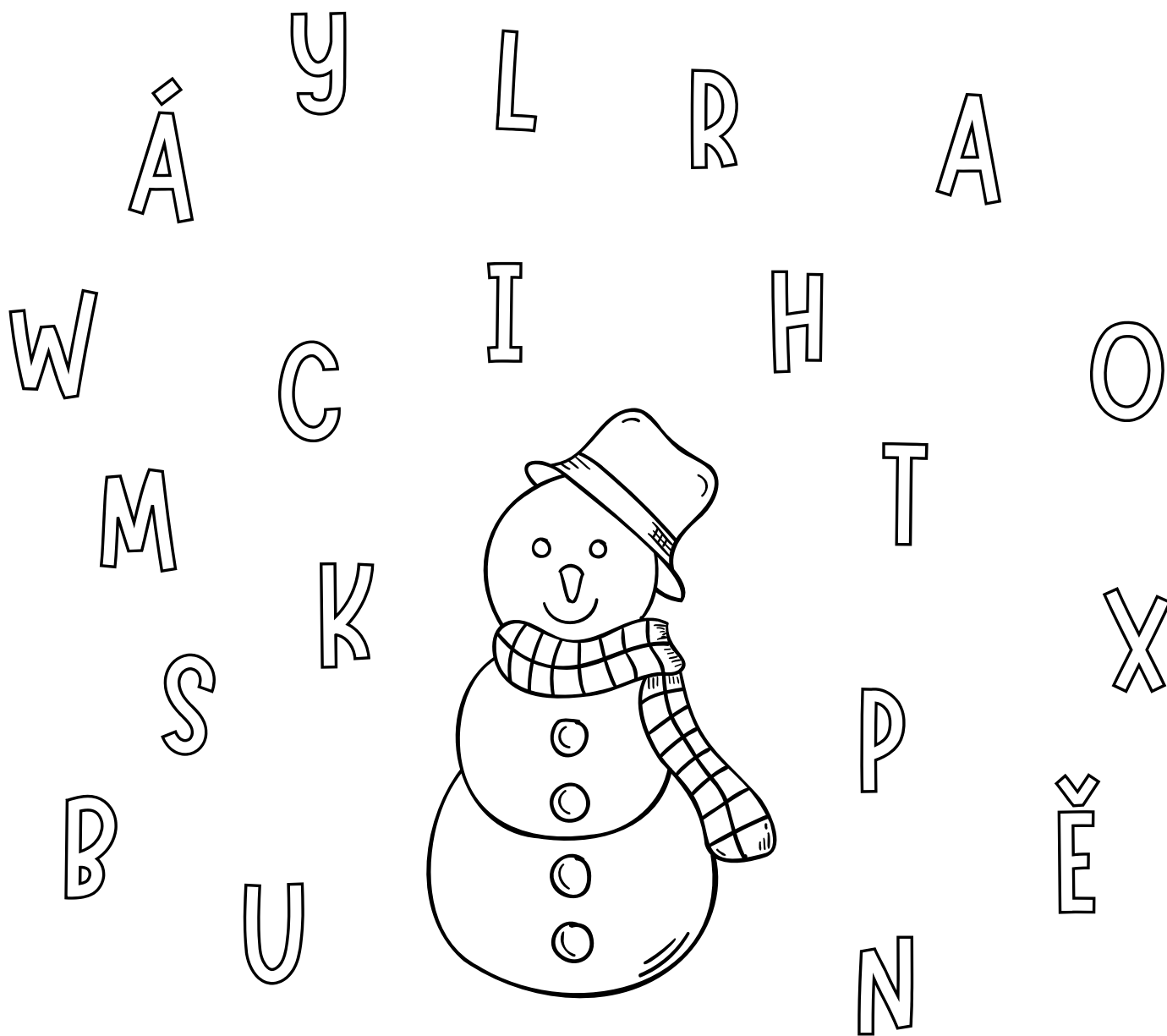

# SNĚHULÁK

Jméno:

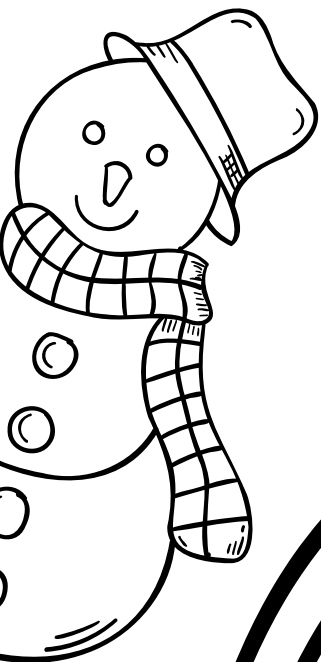

# Sněhulák ztratil nos.

Pomůžeš najít sněhulákovi jeho nos?

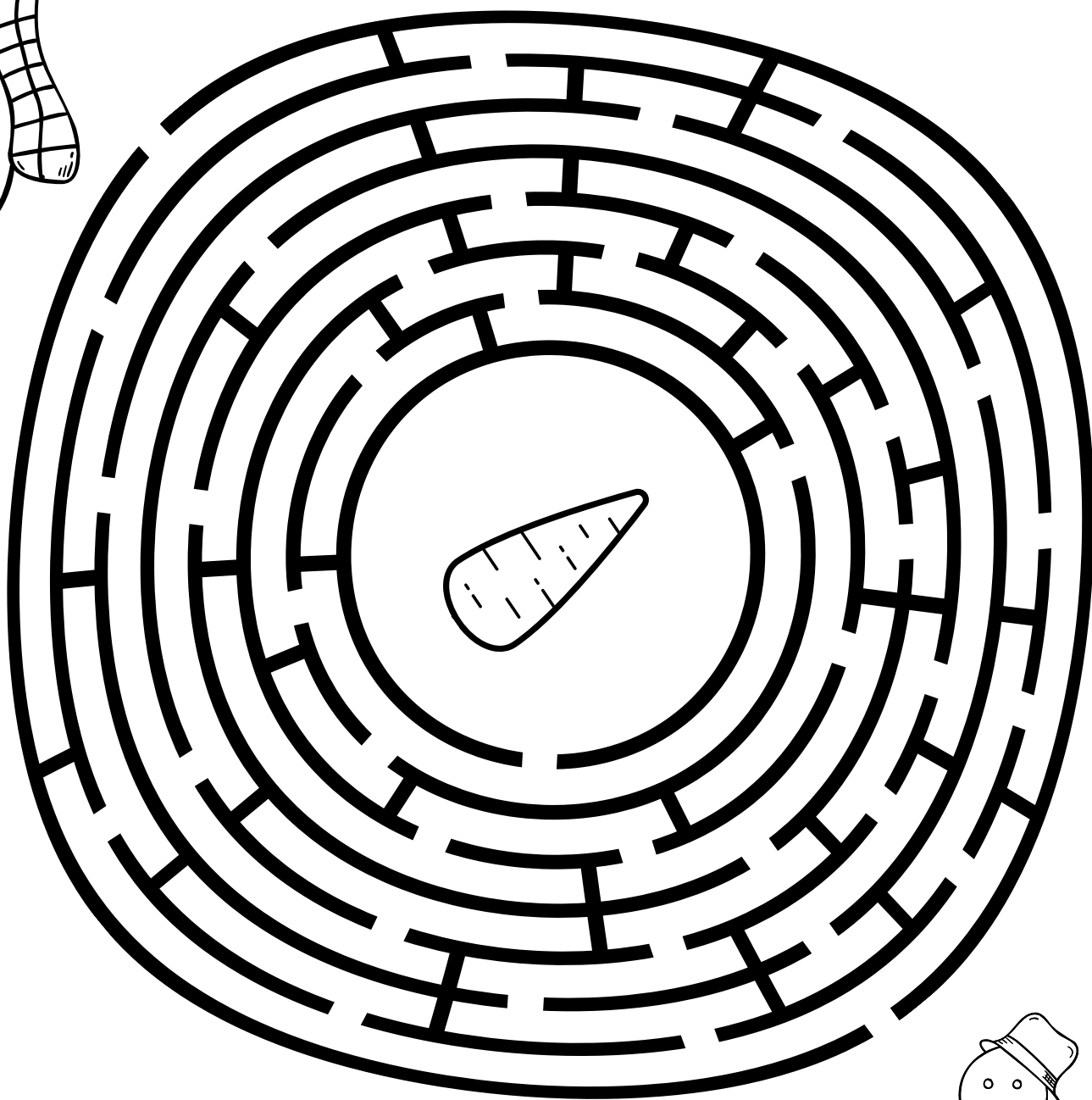

Jméno:

# Vánoční svetr.

Vymaluj svetr pro Barnabáše.



Jméno:

# Jak to bylo dál?

Vystříhni obrázky a pokračuj v řadě.

